

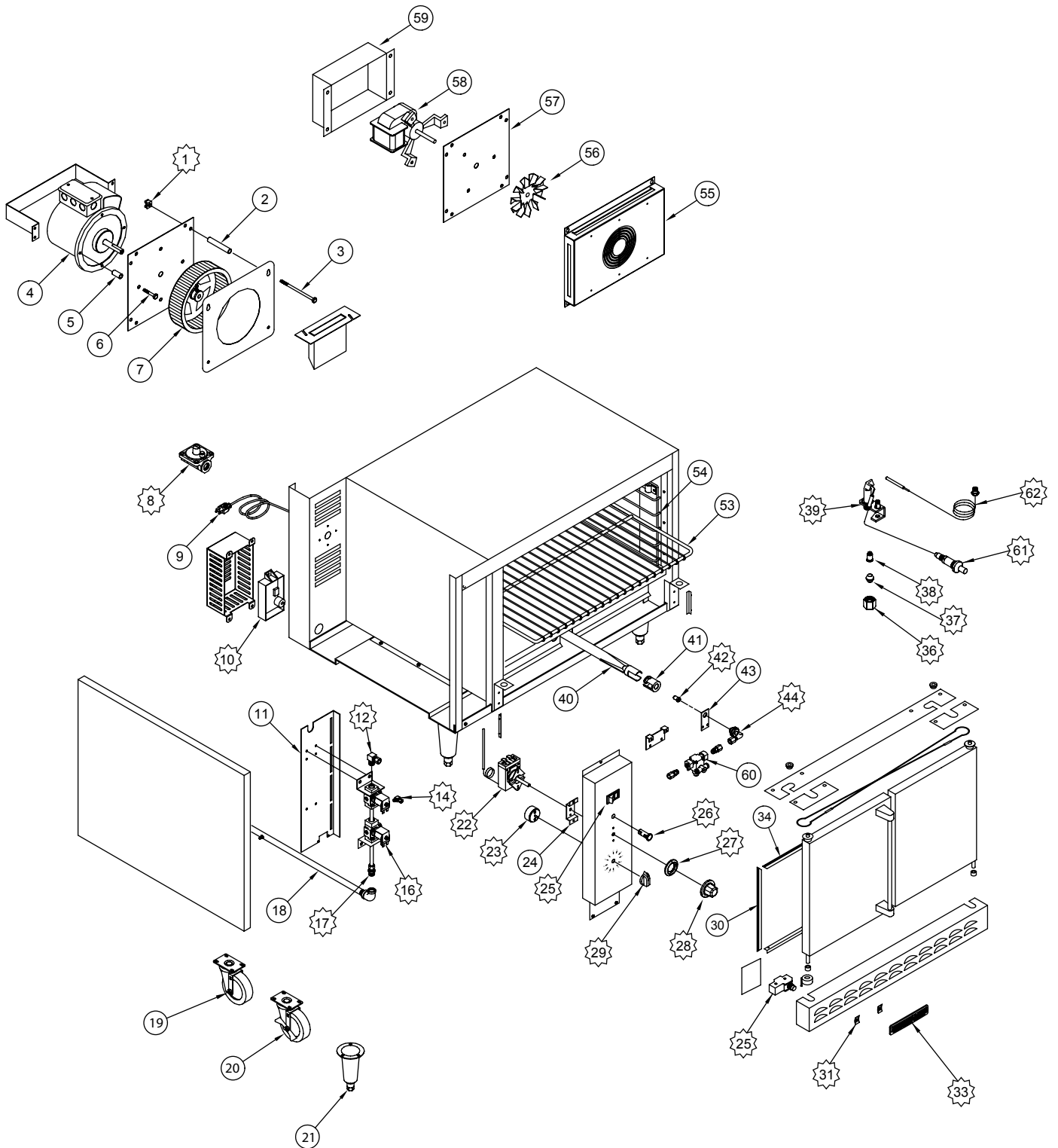









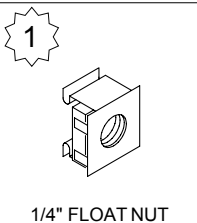

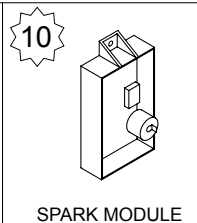
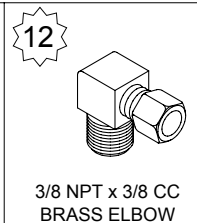

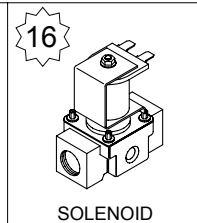
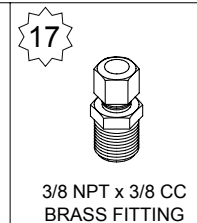
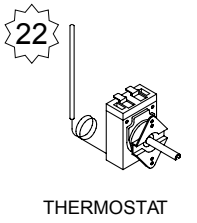
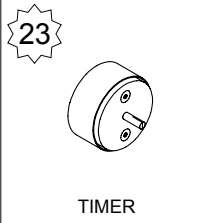
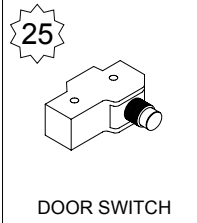
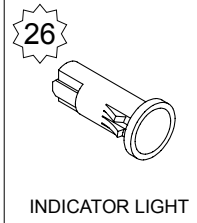

# ARTL

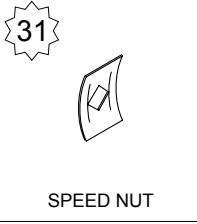

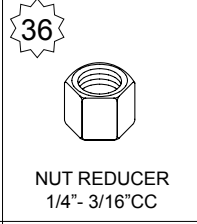
# ARTL

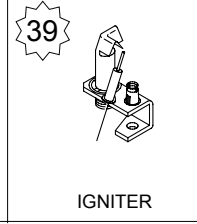
| ITEM NO. | PART NO. | DESCRIPTION   |
|----------|----------|---|
| 1        | A44001   | Nut, Cage 1/4-20 Black  |
| 2        | A43023   | Sleeve, 3/8" X 3/16" Stainless                                  |
| 3        | A42022   | Bolt, Hex 1/4" X 5" GRD 5 ZP                                    |
| 4        | A91004   | Motor, ARC 115V 1/5HP 56YZ FLG                                  |
| 5        | A43026   | Spacer Short  |
| 6        | A42004   | Bolt, Hex GR5 1/4-20 X 1-3/8                                    |
| 7        | A91200   | Blower, Motor Wheel ARC   |
| 8        | A80110   | Valve, Pressure Regulator 3/4" Nat Gas Set 5.0                  |
|          | A80011   | Valve, Pressure Regulator 3/4" LPG Gas Set 10.0                 |
| 9        | A13100   | Cord, Power NEMA 5-15P SJT 16/3"                                |
| 10       | A10062   | Control, Gas Pilot Ignition Pilot Spark 120V MSD/Majestic/SAG   |
| 11       | A99711   | Mounting Panel for Components 1328                              |
| 12       | A28014   | Elbow, 3/8" Compression Brass 10019                             |
| 13       | A10052   | Spark Cable, Teflon w/1/4" QC Insulated Term. Short             |
| 14       | A29303   | Elbow, 3/16" CC - 1/8" Comp Brass 10000                         |
| 15       | A10053   | Cable, Flame Sense 3/16" QC Fully Insulated Term. MSD/ARC Short |
| 16       | A80101   | Solenoid, Valve Safety Gas 115V 10415-73462 HD/AR6C/M1/MSD/SAG  |
| 17       | A28032   | Fitting, 3/8" C X 3/8" MIP Brass                                |

subject to change without notice.

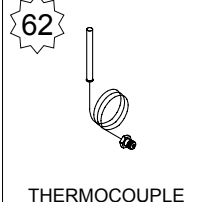
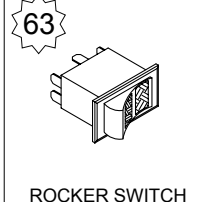
|  |   |   |   |   |   |   |
|--|---|---|---|---|---|---|
|  <p>1<br/>1/4" FLOAT NUT</p>  |  <p>8<br/>REGULATOR</p>                       |  <p>10<br/>SPARK MODULE</p>                   |  <p>12<br/>3/8 NPT x 3/8 CC<br/>BRASS ELBOW</p> |  <p>14<br/>ELBOW<br/>3/16"CC - 1/8"COMPC</p> |  <p>16<br/>SOLENOID</p>         |  <p>17<br/>3/8 NPT x 3/8 CC<br/>BRASS FITTING</p> |
|  <p>22<br/>THERMOSTAT</p>    |  <p>23<br/>TIMER</p>                         |  <p>25<br/>DOOR SWITCH</p>                   |  <p>26<br/>INDICATOR LIGHT</p>                 |  <p>27<br/>BEZEL</p>                        |  <p>28<br/>THERMOSTAT DIAL</p> |  <p>29<br/>TIMER KNOB</p>                        |
|  <p>31<br/>SPEED NUT</p>     |  <p>33<br/>AMERICAN RANGE<br/>NAME PLATE</p> |  <p>36<br/>NUT REDUCER<br/>1/4"- 3/16"CC</p> |  <p>37<br/>SLEEVE, BALL<br/>3/16" FERRULE</p>  |  <p>38<br/>ORIFICE BELL</p>                 |  <p>39<br/>IGNITER</p>         |  <p>42<br/>ORIFICE HOOD</p>                      |
|  <p>44<br/>ORIFICE ELBOW</p> |  <p>61<br/>PIEZO IGNITOR</p>                 |  <p>62<br/>THERMOCOUPLE</p>                  |  <p>63<br/>ROCKER SWITCH</p>                   |   |   |   |

# ARTL

| ITEM NO. | PART NO. | DESCRIPTION   |
|----------|----------|---|
| 18       | A15037   | Manifold Pipe (Convection) AR 10101                                   |
| 19       | A35014   | Caster, 4" Swivel Plate Mount No Brake NSF AR,AGBU,ACB                |
| 20       | A35015   | Caster, 4" Swivel Plate Mount W/Brake NSF AR,AGBU,ACB                 |
| 21       | A35001   | Leg, 6" Cone 3"Adjustable Bullet                                      |
| 22       | A11105   | Thermostat, KXT Electric M/MSD 10404 ARC/SAG                          |
| 23       | A60001   | Timer, Cooking 60 Minute 10408 M/MSD/ARC                              |
| 24       | A99712   | Bracket, KXT Thermostat M/MSD 1330 ARC                                |
| 25       | A10009   | Switch, Rocker 3 Position 10406 M/MSD Series, ARC                     |
|          | A10002   | Switch, Rocker ON/OFF Innovection Oven                                |
| 26       | A10011   | Light, Indicator 120 V Red 12.7 10407 W/Wire Lead & Male Term         |
| 27       | A32023   | Bezel, KXT-397-36 Thermostat 10440-C M/MSD/ARC                        |
| 28       | A32005   | Knob, Dial KXT Thermostat 10411 M/MSD Series, ARC/SAG                 |
| 29       | A32017   | Timer, Knob M/MSD Series 10409  |
| 30       | A99708   | Gasket Door Sides 1323  |
| 31       | A44003   | Nut, Speed #6 Push Black 10601  |
| 33       | A38000   | Name Plate, American Range 8" 10499 Quality Commercial Chrome         |
| 34       | A99707   | Door Gasket (Top & Bottom) 1322                                       |
| 36       | A28020   | Nut, Reducer 1/4" - 3/16" CC  |
| 37       | A28021   | Sleeve, Ball 3/16" Tube Barrel Oversize                               |
| 38       | A11118   | Orifice, Bell .018 AR/AF NAT Gas 11001                                |
|          | A11110   | Orifice, Bell .010 LPG Gas 11002                                      |
| 39       | A11104   | Pilot, NAT Gas .018 5SL-2 AR/SAG 10413                                |
|          | A11132   | Pilot, LP Gas, .010 AR/SAG 10413L                                     |
| 40       | R14020   | Burner, Bake Oven ARROB/ARRSB/AR Ranges                               |
| 41       | A14049   | Air Shutter, 1"   |
| 42       | A29000   | Orifice Hood, #39 1/2" Brass 11039 Nat Gas (Convection & Innovection) |
|          | A29001   | Orifice Hood, #52 1/2" Brass 11052 LPG Gas (Convection LP)            |
|          | A29007   | Orifice Hood, #53, 1/2" Brass (Innovection LP)                        |
| 43       | A99713   | Bracket, Orifice Bracket ARC 1341                                     |
| 44       | A24000   | Elbow, Orifice, Mixer 3/8" C-3/8-27 10442                             |
| 45       | A99517   | Bracket Switch for Door ARC 10122                                     |
|          | A99518   | Bracket, Door Switch for 60" UNIT 10123                               |
| 46       | A10024   | Switch, AR6C Oven Door Snap Action Roller/Lever Style                 |
| 53       | A31006   | Rack, Oven AR-C 10501 25-3/4" X 21-1/2" (Convection)                  |
|          | A31025   | Rack, Oven AR6 26-3/8" X 20-7/8" (Innovection)                        |
| 54       | A31008   | Rack Guide, ARC Right 1320R (Convection)                              |
|          | A31007   | Rack Guide, ARC Left 1320L (Convection)                               |
| 55       | A91202   | Blower Baffle (Innovection)   |
| 56       | A91206   | Fan, Blade Innovection Motor (Innovection)                            |
| 58       | A91100   | Motor, Innovection Fan Assembly ARR-RANGE Series (Innovection)        |
| 60       | A80100   | Valve, Safety TS-11J AR Ranges 10425                                  |
| 61       | A10010   | Igniter, Piezo & Locking Nut  |
| 62       | A11100   | Thermocouple, 18" 2C AR Range   |
| 63       | A10009   | Switch, Rocker 3 Position 10406 M/MSD Series, ARC                     |

subject to change without notice.